

DISCONNECT ALL SUPPLY VOLTAGES BEFORE WORKING ON ANY EQUIPMENT.

Fig. 1
Conventional HVAC unit with other soft starters installed.

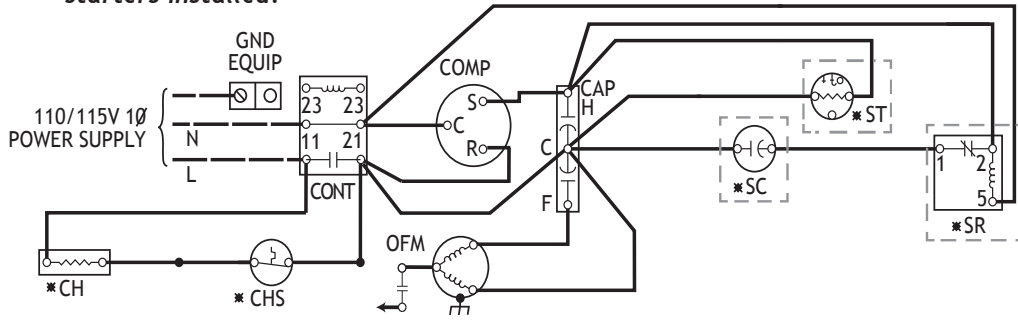

Sample Wiring Schematic

- LEGEND -

- Factory Power Wiring
 - - - Field Power Wiring
 - Factory Control Wiring
 - - - - Field Control Wiring
 - ==== Conductor On Circuit Board
 - Component Connection
 - 1/4 in. Quick Connect Terminals
 - Junction
 - CAP Capacitor (Dual Run)
 - *CH Crankcase Heater
 - *CHS Crankcase Heater Switch
 - COMP Compressor
 - CTD Compressor Time Delay
 - CONT Contactor
 - CB Circuit Board
 - OFM Outdoor Fan Motor
 - * ST Start Thermistor
 - * SR Start Relay
 - * SC Start Capacitor
- NOTE: If installed, remove all of the above devices
- * May be factory or field installed

Fig. 2
Installing SureStart

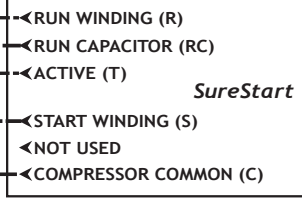
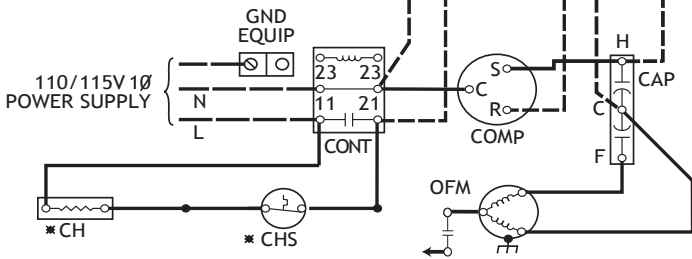

LED Flash Codes *

NOTE: LED fault indication is turned off in normal running mode.

Flash Code	Definition	Time to re-start attempt
Rapid Flash (10/1 sec)	Low Voltage	3 min
Triple Flash (3/3 secs)	Lockout on 3 failed starts	50 min
Slow Flash (1/3 secs)	Lockout on overcurrent	10 min
Steady Flash (1/1 sec)	Cycle delay / Faults	3 min

* Refer to SureStart submittal set for detailed flash code descriptions.

Review the schematic carefully to identify the connection points.

CAUTION: The Run Winding is not connected to the Run Capacitor. The Run Capacitor is usually 20 to 60 µF.

WARNING: 1) All voltage to equipment **MUST** be disconnected before removing any devices.

2) Allow 2 minutes to discharge run capacitor before disconnecting.

3) Prior to installation, be sure all start capacitors & start relays, along with hard-starters and/or any other related devices, are removed.

4) Do not swap the Run & Start Windings.

5) The start capacitor is built into the soft starter.

6) In accordance with UL508 standard, use the below tightening torques. Loose terminals can lead to heating & subsequent damage to the soft starter.

7) **OPENING OF THE SOFT STARTER UNIT WILL VOID THE WARRANTY!**

FIELD WIRING TERMINALS:

Wire Range: 8 to 12 AWG Cu, stranded, for terminals (Run Winding (R) and Active(T))

12 to 16 AWG Cu, stranded, for terminals (Run Capacitor (RC), Start Winding (S), and Compressor/Motor Common (C), these are supplied)

Tightening Torque: 11.5 lbs-in large terminals, 4.5lbs-in small terminals.

Field wiring conductors shall be rated 167°F [75°C]

Minimum end use enclosure size: 10" x 8" x 6"

Suitable for use on a circuit capable of delivering no more than 5000rms symmetrical amperes, 240 volts maximum, when protected by a non-time delay RK5 fuse or circuit breaker rated 80A, or a time delay fuse rated 70A. The device does not provide current limiting control or equivalent.

SureStart is **NOT** an overcurrent protection device and must **NOT** be used as a replacement for any primary circuit overcurrent protection.

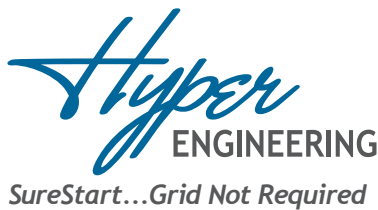

Parts List

- 1 - SureStart Soft Starter
- 1 - Red Lead
- 1 - Blue Wire
- 1 - Black Wire
- 1 - Brown Wire
- 1 - Mounting Block
- 1 - Green Terminal

INSTRUCTION GUIDE
SureStart 110/115V HVAC Installation
For SureStart SSOx Series

Typical HVAC Application



1) Disconnect all voltage to the HVAC equipment.



2) Secure the base for the SureStart inside control box.



3) Remove the compressor **RUN WIRE** from the contactor or **RUN CAPACITOR TERMINAL**, as applicable.



4) Strip the compressor **RUN WIRE** at least 1/2 in.



5) Attach the compressor **RUN WIRE** to the SureStart **RUN WINDING** terminal.



6) Attach the **BROWN WIRE** supplied with the SureStart to the **RUN CAPACITOR TERMINAL** on the Sure-Start.

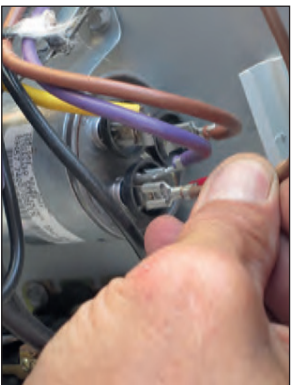

7) Identify the cable connecting the contactor and the **RUN CAP**. Remove the connection to the **RUN CAP**. Attach the flagged end of the **BROWN WIRE** the same terminal of the **RUN CAP**. **

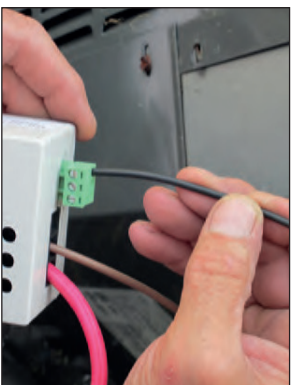

8) Attach the **BLACK WIRE** (supplied) to **COMPRESSOR COMMON** on the SureStart **GREEN TERMINAL CONNECTOR**.



9) Attach the flagged end of the **BLACK WIRE** to the **COMPRESSOR COMMON** on the "T" side of the contactor.

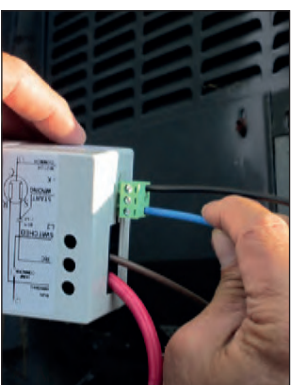

10) Attach the **BLUE WIRE** (supplied) to the **START WINDING** on the SureStart **GREEN TERMINAL CONNECTOR**.



11) Attach the flagged end of the **BLUE WIRE** to the other terminal of the **RUN CAPACITOR**. Ensure that this terminal on the capacitor also joins to the **START WINDING** of the compressor. (This is the Herm (H) terminal for Dual Compressor/Fan Capacitors.)



12) Attach the **RED WIRE** (supplied) to the **ACTIVE TERMINAL** on the SureStart.



13) Remove the loose wire (from step 7) from the **ACTIVE** input of the contactor and attach the stripped end of the **ACTIVE WIRE** in its place.



14) Apply power to the equipment and cycle to ensure proper operation.



In accordance with UL-508 standard, use the following torque settings:
1.1. 5lbs-in large terminals
4.5lbs-in small terminals

** (This is the Common (C) terminal for Dual Compressor/Fan Capacitors.)

NOTE: The SureStart device could take up to six (6) starts to optimize performance.